

Mesa despacho Eko

Instrucciones de montaje



Te aconsejamos

Ordena y cuenta las piezas y herramientas

Habilita una zona para el montaje





No fuerces los tornillos y los elementos de montaje

Sigue paso a paso las instrucciones de montaje

Las herramientas que necesitas (no incluidas)

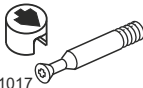

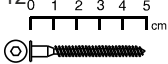
Los herrajes que encontrarás en el kit

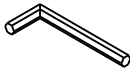
Exc x 6 Nº721016/721017		G33 x 4 Nº710049		Lzgr x 1 Nº721034		Autgr x 12 Nº721002	
Tac x 6 Nº721045		Lzpq x 1 Nº710251					

Bolsa para los cajones

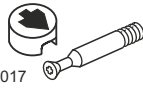
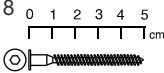
Excpcq x 8 Nº721126/721017		Autpcq x 8 Nº710250	
-------------------------------	---	------------------------	---

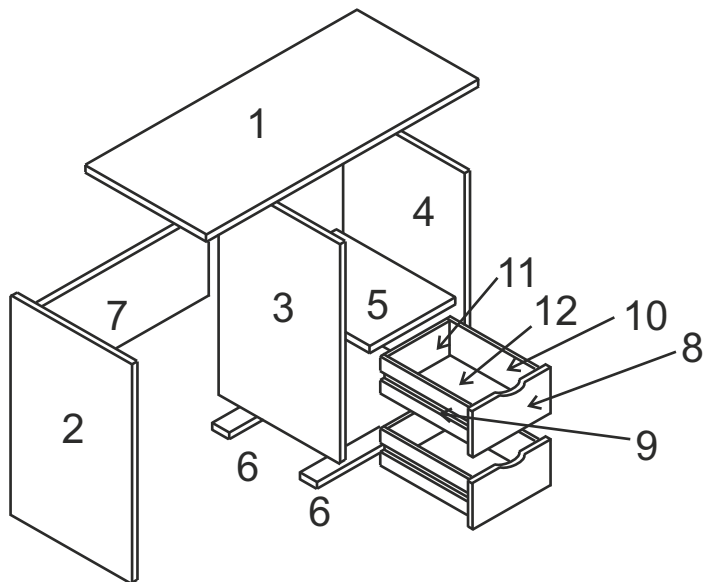

Las piezas incluidas en el kit



1
Tapa
1150x500 mm
100531/600531



2
Lateral izqdo
740x450 mm
100515/600515

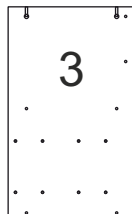

3
Centro
740x450 mm
100550/600550

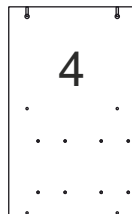

4
Lateral drcho
740x450 mm
100514/60514



5
Balda
446x362 mm
100520/600520

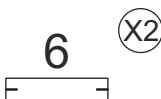

6 (X2)
Tarima
362x80 mm
1005770/600570



7
Pieza trasera
700x224 mm
100575/600575

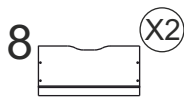

8 (X2)
Frente cajón
359x176 mm
100560/600560

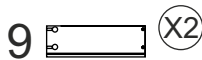

9 (X2)
10 (X2)
Costillas laterales
350x110 mm
1350115/1350116

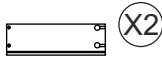

11 (X2)
Costilla fondo
333x110 mm
1333119

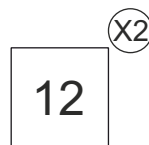

12 (X2)
Fondo cajón
350x345 mm
8100574

CONDICIONES DE USO Y MANTENIMIENTO

Producto de uso doméstico.

Evitar colocar el mueble cerca de fuentes de calor, de humedad o de una fuerte luz solar.

No lo limpie con productos abrasivos, ni disolventes.

Quitar el polvo antes de limpiarlo.

Utilizar un paño húmedo, limpio y sin pelos.

CONDIÇÕES DE USO E MANUTENÇÃO DO MÓVEL

Produto de uso doméstico.

Evitar colocar o móvel próximo a fontes de calor, de humidade ou exposto a luz solar intensa.

Não limpar com produtos abrasivos ou produtos de limpeza com solvente.

Eliminar o pó antes de qualquer processo de limpeza.

É recomendável utilizar um pano húmido, limpo e sem pelos.

ATENCIÓN AL CLIENTE
ATENDIMENTO AO CLIENTE

(+34)964 321 111

HORARIO: 8-13h 15-17:30h de lunes a viernes

Web: www.mueblespitarch.com

e-mail: comercial@mueblespitarch.com

LOTE 5314/5315

1

El primer paso es el montaje de los herrajes

Exc x 6



Tac x 6



G33 x 4

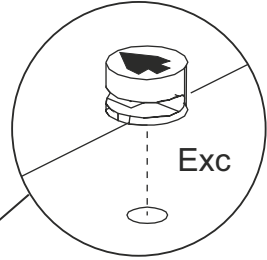
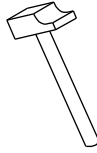

Exc

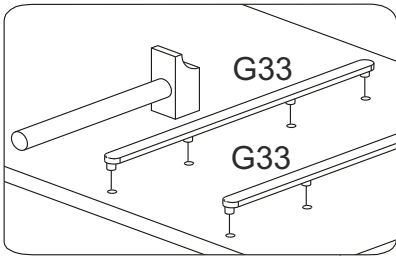

G33

G33

3

4

2

Tac

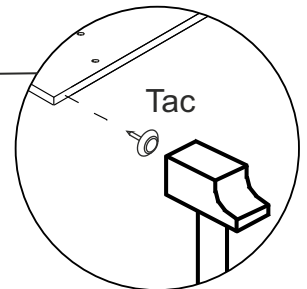

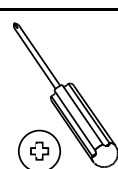
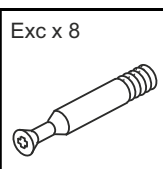
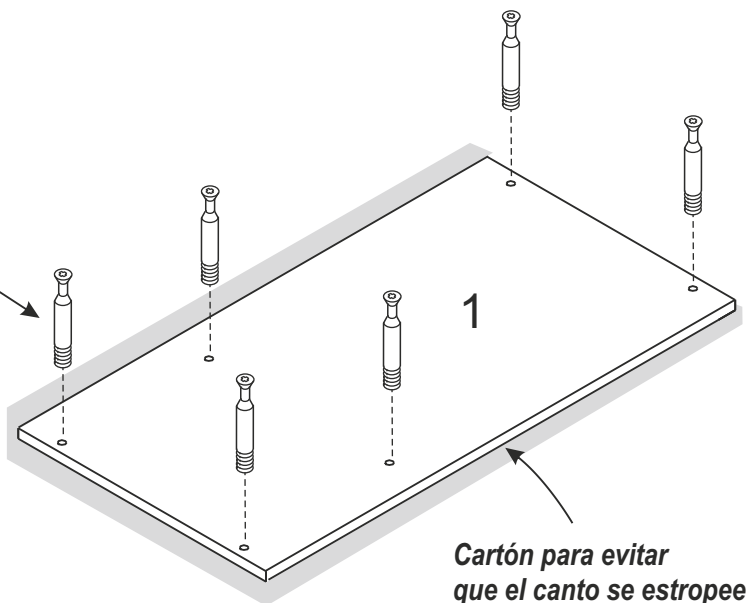
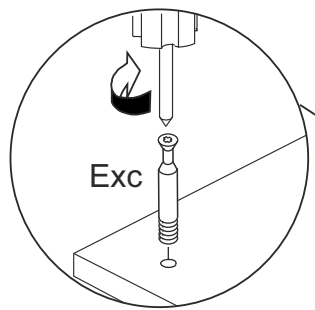
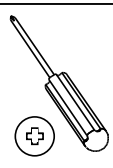
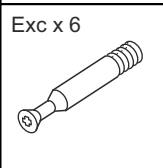

Bolsa para los cajones

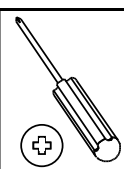
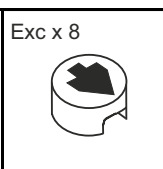
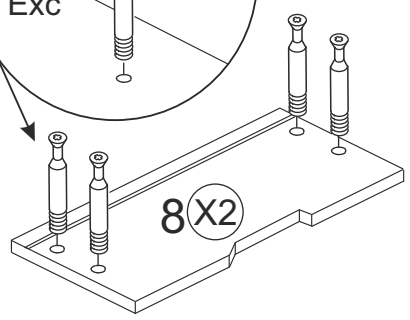
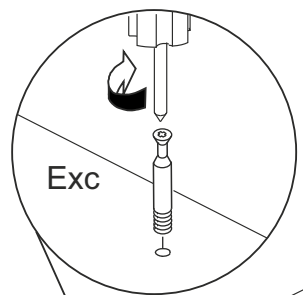

Bolsa para los cajones

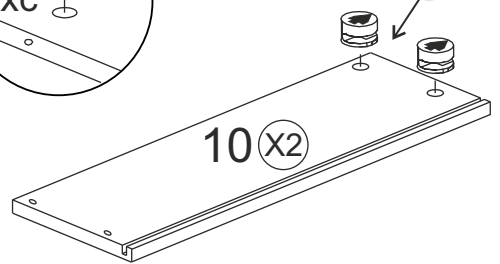
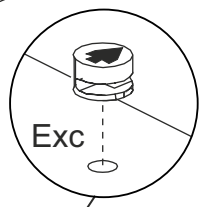
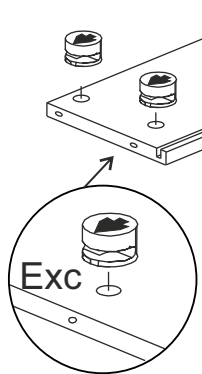

2

Autpq x 8



Lzpq x 1

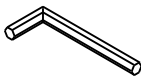

Los 2 cajones se montan igual

Bolsa para los cajones

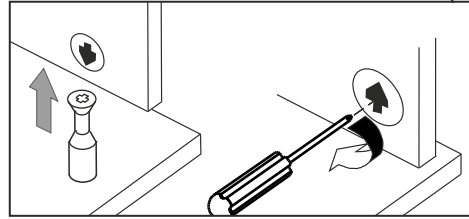
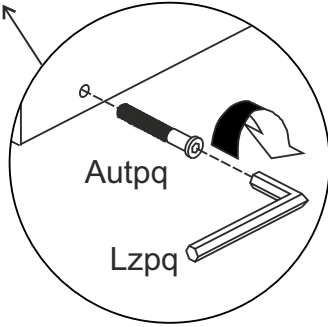
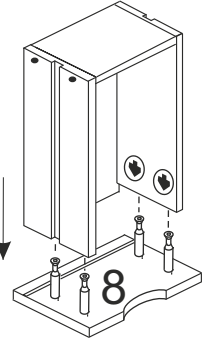
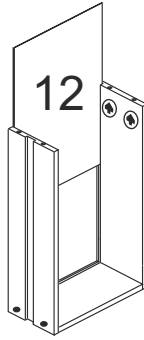
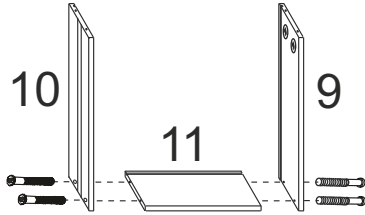

3

Autgr x 8



Lzgr x 1

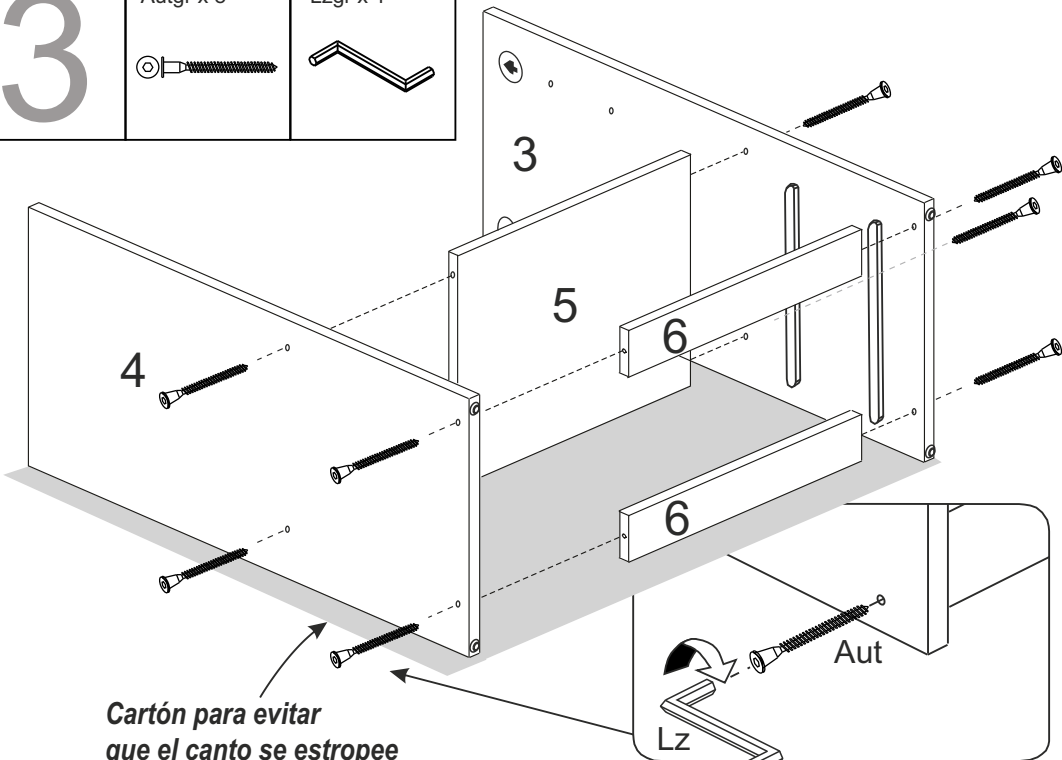
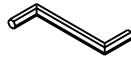

Cartón para evitar que el canto se estropee

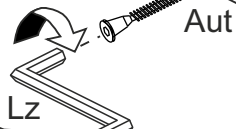

4

Autgr x 4



Lzgr x 1

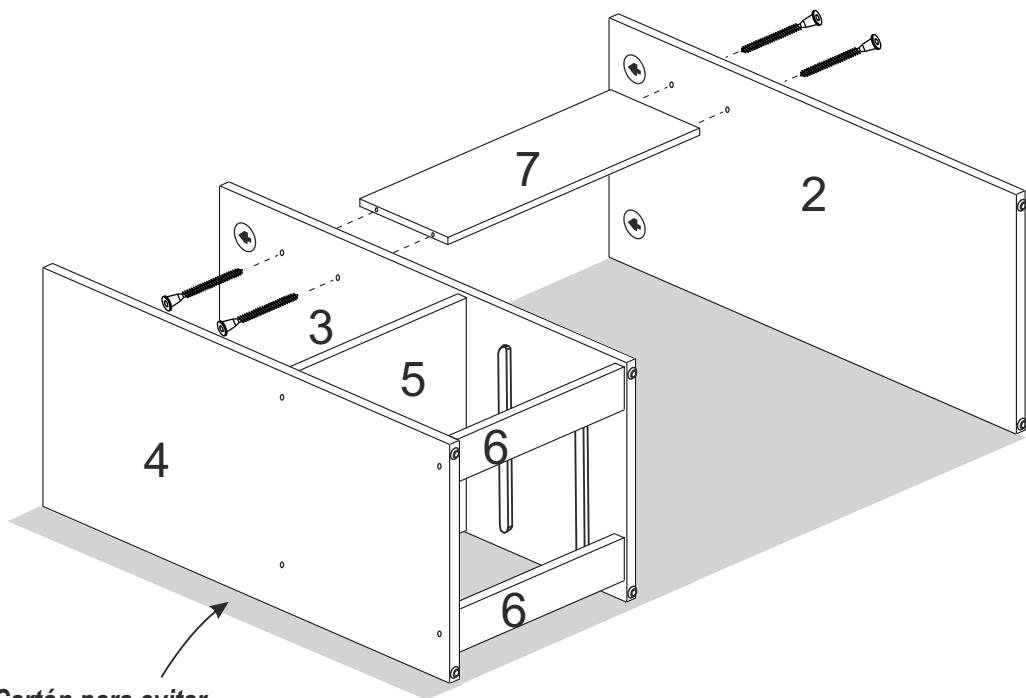
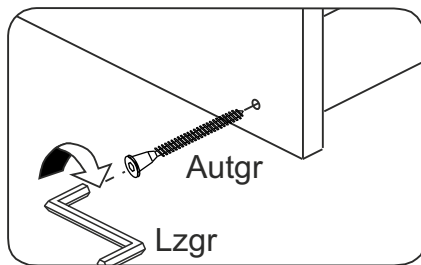

*Cartón para evitar
que el canto se estropee*

5

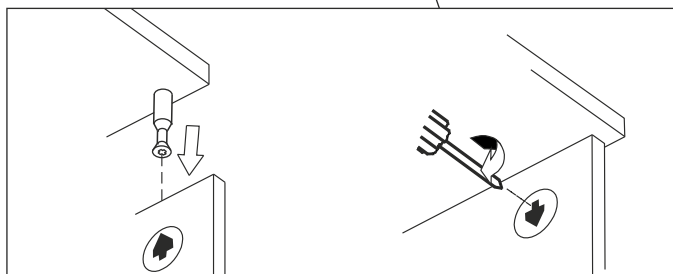
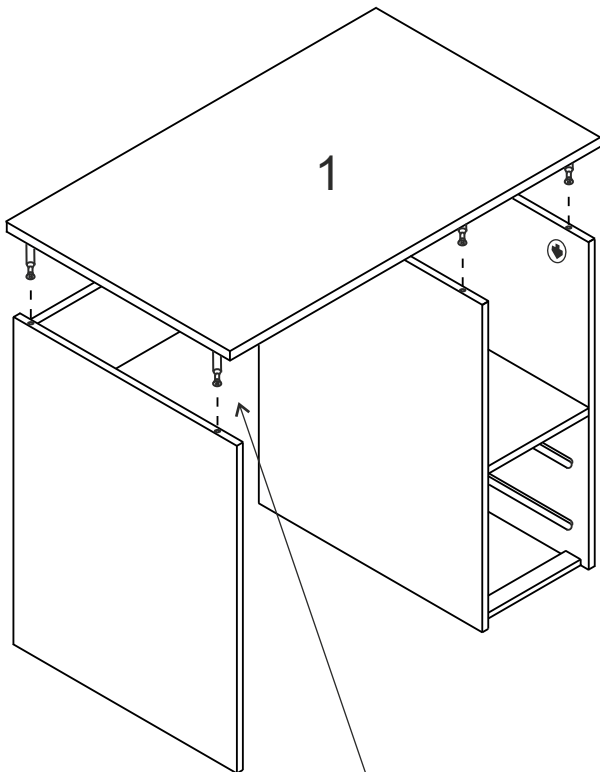
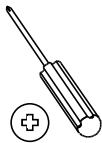

6

